

CHEMICAL ENGINEERING

CHEMICAL ENGINEERING GATE

Previous Years Solved Papers
2000-2024

Descriptive & Easy language

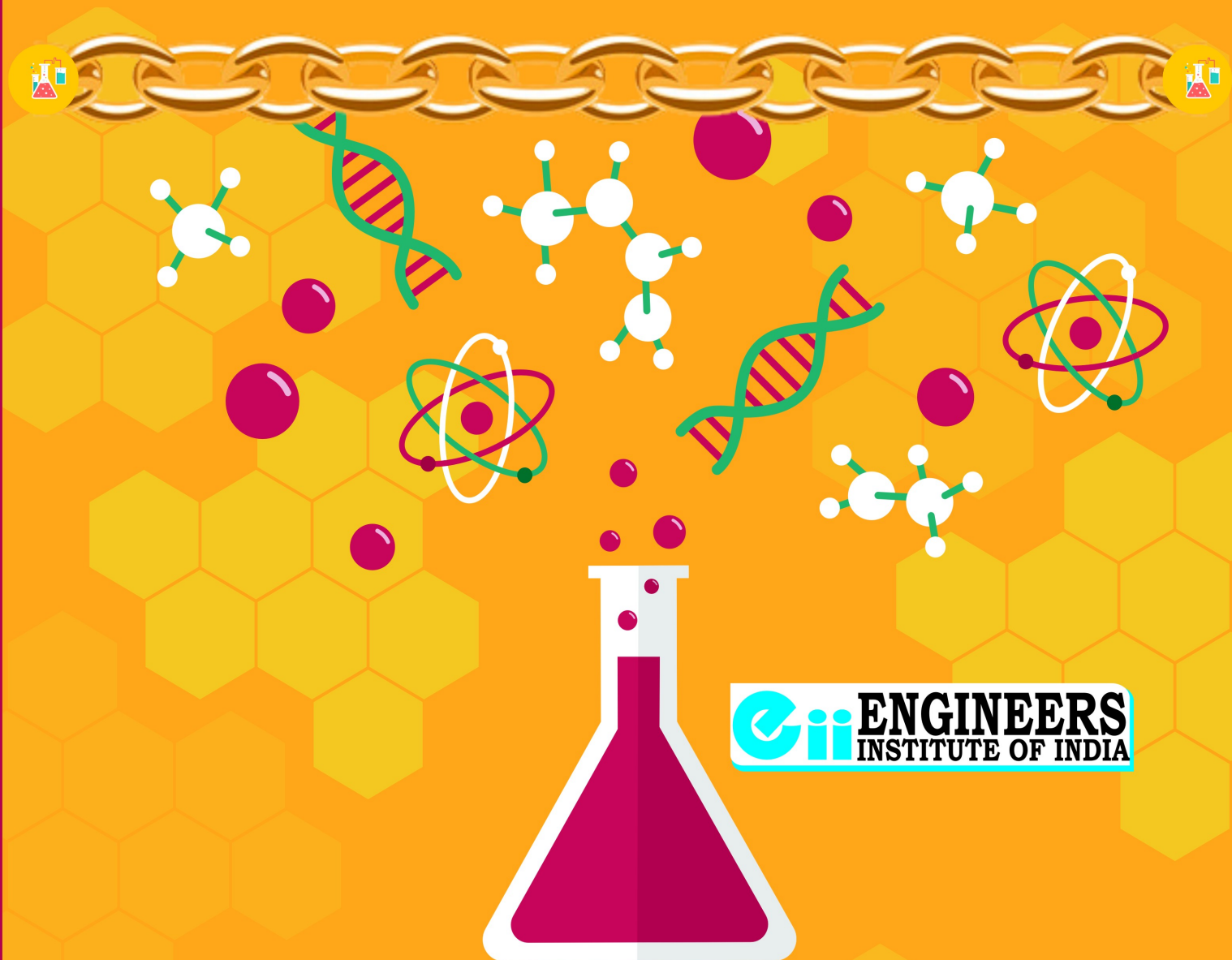

eii ENGINEERS
INSTITUTE OF INDIA

GATE SOLVED PAPER

CHEMICAL ENGINEERING

GATE SOLUTION

2000 to 2024 Error Free Solutions

Subject-wise descriptive Solutions



Ei ENGINEERS INSTITUTE OF INDIA

Unparallel Results+UnMatched Quality

GATE-2023 Chemical Engineering

Congratulations !!!

8 Rank in Top 10

Congratulations !!!

 1 Rank ROHIT BHAGAT KALWAR	 2 Rank HARSHIT GUPTA	 3 Rank RAVI SHANKAR	 4 Rank ANANTHANARAYANAN POTTI S
 6 Rank BIBEKANANDA SAHOO	 6 Rank KARTIK DILIPKUMAR CHADDARWALA	 8 Rank SATYASHEKHAR VELAMALA	 10 Rank BIRUPAKHYA PATRO
 11 Rank RAKHAL BANERJEE	 13 Rank HARAPRASAD DASH	 17 Rank ARPIT BHARDWAJ	 18 Rank HATIF HAIDER KHAN
 18 Rank DINESH DEVHARE	 21 Rank ARAVIND B MENON	 24 Rank UDDANTI GOUTHAM	 24 Rank NEELSIKH RAJPUT
 29 Rank DIVYARAJSIKH MULUBHA VALA	 31 Rank SHIVANSHU TEWARI	 31 Rank DEEPAK GOCHAR	 37 Rank PRATIK KUMAR PATRA

**This Book is dedicated to all
Chemical Engineers Preparing for
GATE & PSUs Entrance**

© 2024 by Engineers Institute of India

ALL RIGHTS RESERVED. No part of this work covered by the copyright herein may be reproduced, transmitted, stored or used in any form or by any means graphic, electronic, or mechanical & chemical, including but not limited to photocopying, recording, scanning, digitizing, taping, Web distribution, information networks, or information storage and retrieval systems.

Engineers Institute of India-EII

61C, Kalu Sarai, Near Hauz Khas Metro Station New Delhi-110016

Tel: 0-9990657855

For publication information, visit www.engineersinstitute.com

ISBN: 978-93-5137-754-2

Price: Rs. 849.00

A word to the students



Er. R.K. Rajesh
(DIRECTOR)

GATE examination is one of the most prestigious competitive examinations conducted for Graduate engineers. Over the past few years, it has become more competitive as a number of aspirants are increasingly becoming interested in M.Tech & government jobs due to decline in other career options.

In my opinion, GATE exam test candidate's basics understanding of concepts, ability to apply numerical approach. A candidate is supposed to smartly deal with the syllabus not just mugging up concepts. Thorough understanding with critical analysis of topics and ability to express clearly are some of the pre-requisites to crack this exam. The questioning & examination pattern has changed in few years, as numerical answer type questions play a major role to score a good rank. Keeping in mind, the difficulties of an average student, we have composed this booklet.

Established in 2006 by a team of IES and GATE toppers, we at **Engineers Institute of India** have consistently provided rigorous classes and proper guidance to engineering students over the nation in successfully accomplishing their dreams. We believe in providing exam-oriented teaching methodology with updated study material and test series so that our students stay ahead in the competition. Many current and past year toppers associate with us for contributing towards our goal of providing quality education and share their success with the future aspirants. Past students of EII are currently working in various candidate's stay ahead government departments and PSU's and pursuing higher specializations. The basic objective of this book is to maintain the standard and uniformity in both teaching and learning. I sincerely express my appreciation and thanks to **Mr. Pradeep Kumar Singh** (M.Tech IITR) and team of EII who directly or indirectly contributed towards this book.

R.K. Rajesh

Director

Engineers Institute of India

eii.rkrajesh@gmail.com

Ph. 9990357855

GATE Syllabus for Chemical Engineering (CH)

ENGINEERING MATHEMATICS

Linear Algebra: Matrix algebra, Systems of linear equations, Eigen values and eigenvectors.

Calculus: Functions of single variable, Limit, continuity and differentiability, Taylor series, Mean value theorems, Evaluation of definite and improper integrals, Partial derivatives, Total derivative, Maxima and minima, Gradient, Divergence and Curl, Vector identities, Directional derivatives, Line, Surface and Volume integrals, Stokes, Gauss and Green's theorems.

Differential equations: First order equations (linear and nonlinear), Higher order linear differential equations with constant coefficients, Cauchy's and Euler's equations, Initial and boundary value problems, Laplace transforms, Solutions of one dimensional heat and wave equations and Laplace equation.

Complex variables: Complex number, polar form of complex number, triangle inequality.

Probability and Statistics: Definitions of probability and sampling theorems, Conditional probability, Mean, median, mode and standard deviation, Random variables, Poisson, Normal and Binomial distributions, linear regression analysis.

Numerical Methods: Numerical solutions of linear and non-linear algebraic equations. Integration by trapezoidal and Simpson's rule. Single and multi-step methods for numerical solution of differential equations.

CHEMICAL ENGINEERING

Process Calculations and Thermodynamics: Steady and unsteady state mass and energy balances including multiphase, multicomponent, reacting and non-reacting systems. Use of tie components; recycle, bypass and purge calculations; Gibb's phase rule and degree of freedom analysis.

First and Second laws of thermodynamics. Applications of first law to close and open systems. Second law and Entropy. Thermodynamic properties of pure substances: Equation of State and residual properties, properties of mixtures: partial molar properties, fugacity, excess properties and activity coefficients; phase equilibria: predicting VLE of systems; chemical reaction equilibrium.

Fluid Mechanics and Mechanical Operations:

Fluid statics, Newtonian and non-Newtonian fluids, shell-balances including differential form of Bernoulli equation and energy balance, Macroscopic friction factors, dimensional analysis and similitude, flow through pipeline systems, flow meters, pumps and compressors, elementary boundary layer theory, flow past immersed bodies including packed and fluidized beds, Turbulent flow: fluctuating velocity, universal velocity profile and pressure drop.

Particle size and shape, particle size distribution, size reduction and classification of solid particles; free and hindered settling; centrifuge and cyclones; thickening and classification, filtration, agitation and mixing; conveying of solids.

Heat Transfer: Steady and unsteady heat conduction, convection and radiation, thermal boundary layer and heat transfer coefficients, boiling, condensation and evaporation; types of heat exchangers and evaporators and their process calculations. Design of double pipe, shell and tube heat exchangers, and single and multiple effect evaporators.

Mass Transfer: Fick's laws, molecular diffusion in fluids, mass transfer coefficients, film, penetration and surface renewal theories; momentum, heat and mass transfer analogies; stage-wise and continuous contacting and stage efficiencies; HTU & NTU concepts; design and operation of equipment for distillation, absorption, leaching, liquid-liquid extraction, drying, humidification, dehumidification and adsorption.

Chemical Reaction Engineering: Theories of reaction rates; kinetics of homogeneous reactions, interpretation of kinetic data, single and multiple reactions in ideal reactors, non-ideal reactors; residence time distribution, single parameter model; non-isothermal reactors; kinetics of heterogeneous catalytic reactions; diffusion effects in catalysis.

Instrumentation and Process Control: Measurement of process variables; sensors, transducers and their dynamics, process modelling and linearization, transfer functions and dynamic responses of various systems, systems with inverse response, process reaction curve, controller modes (P, PI, and PID); control valves; analysis of closed loop systems including stability, frequency response, controller tuning, cascade and feed forward control.

Plant Design and Economics: Principles of process economics and cost estimation including depreciation and total annualized cost, cost indices, rate of return, payback period, discounted cash flow, optimization in process design and sizing of chemical engineering equipments such as compressors, heat exchangers, multistage contactors.

Chemical Technology: Inorganic chemical industries (sulphuric acid, phosphoric acid, chlor-alkali industry), fertilizers (Ammonia, Urea, SSP and TSP); natural products industries (Pulp and Paper, Sugar, Oil, and Fats); petroleum refining and petrochemicals; polymerization industries (polyethylene, polypropylene, PVC and polyester synthetic fibres).

Syllabus for General Aptitude (GA)

Verbal Ability: English grammar, sentence completion, verbal analogies, word groups, instructions, critical reasoning and verbal deduction.

Numerical Ability: Numerical computation, numerical estimation, numerical reasoning and data interpretation.

CONTENTS

1. Chemical Reaction Engineering	01-75
2. Heat Transfer	76-130
3. Mass Transfer.....	131-191
4. Instrumentation and Process Control	192-246
5. Thermodynamics	247-292
6. Fluid Mechanics.....	293-337
7. Process calculations	338-364
8. Mechanical Operations.....	365-390
9. Plant Design and Economics	391-411
10. Chemical Technology	412-439
11. Engineering Mathematics.....	440-508
12. GATE-2020 Questions & Solutions	509-556
13. GATE-2021 Questions & Solutions	557-592
14. GATE-2022 Questions & Solutions	593-641
15. GATE-2023 Questions & Solutions	642-679
16. GATE-2024 Questions & Solutions	680-715

Eii ENGINEERS INSTITUTE OF INDIA

Unparallel Results+UnMatched Quality

GATE-2024 Chemical Engineering
6 Rank in Top 10



3

Rank

KRISH PARADVA



4

Rank

SMIT MAGANLAL VAGADIYA



5

Rank

TUTHIKA MAHESH ANIL



6

Rank

PARAM AGRAHARI



6

Rank

DEBARGHYA CHAKRABARTI



9

Rank

KEVAL VASOJA

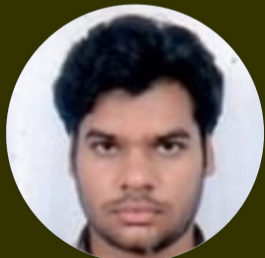

11

Rank

PRAVEEN KUMAR YADAV



15

Rank

BRANZIL



16

Rank

NISTHA ROY



39

Rank

MANSUR MUSTAFA



42

Rank

NITIN SINGH



52

Rank

NISHANT PATHAK

and many more

Eii ENGINEERS INSTITUTE OF INDIA

Unparallel Results+UnMatched Quality

GATE-Chemical Engg. 9 Times AIR-1



GATE 2023
8 Rank in Top 10



1
Rank

ROHIT BHAGAT
KALWAR

GATE 2022
8 Rank in Top 10



1
Rank

TETALA MANI
SANDEEP REDDY



GATE 2021
7 Rank in Top 10



1
Rank

DHRUVAL KUMAR
THAKKAR

GATE 2020
10 Rank in Top 10



1
Rank

SACHIN

GATE 2019
9 Rank in Top 10



1
Rank

SHASHWAT
RAGHUVANSHI

GATE 2018
8 Rank in Top 10



1
Rank

PRASHANT
VARSHNEY

GATE 2016
6 Rank in Top 10



1
Rank

RONIKA
GOSWAMI

Admission Open : 9990657855 www.engineersinstitute.com

To Buy Postal Correspondence Packages call at 0-9990657855

1. CHEMICAL REACTION ENGINEERING
(GATE Previous Papers)

GATE-2019

1. The desired liquid-phase reaction (1-Mark)



is accompanied by an undesired side reaction



Four isothermal reactor schemes (CSTR: ideal Continuous-Stirred Tank Reactor; PFR: ideal Plug Flow Reactor) for processing equal molar feed rates of D and E are shown in figure. Each scheme is designed for the same conversion. The scheme that gives the most favorable product distribution is:

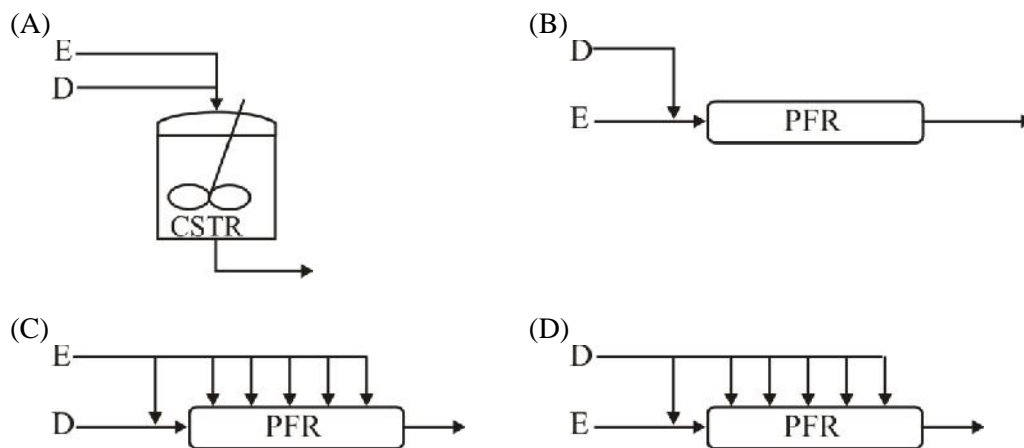

2. For a first order reaction in a porous spherical catalyst pellet, diffusional effects are most likely to lower the observed rate of reaction for (1-Mark)

- (A) slow reaction in a pellet of small diameter
(B) slow reaction in a pellet of large diameter
(C) fast reaction in a pellet of small diameter
(D) fast reaction in a pellet of large diameter

3. The elementary, irreversible, liquid-phase, parallel reactions, $2A \rightarrow D$ and $2A \rightarrow U$, take place in an isothermal non-ideal reactor. The C-curve measured in a tracer experiment is shown in the figure, where $C(t)$ is the concentration of the tracer in g/m^3 at the reactor exit at time t (in min). (2-Marks)

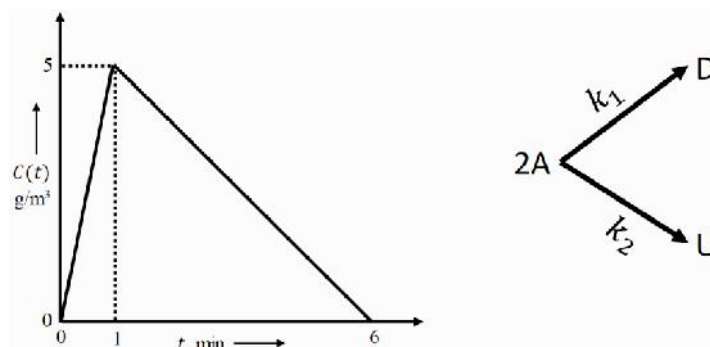

The rate constants are $k_1 = 0.2$ Liter/(mol min) and $k_2 = 0.3$ Liter/(mol min). Pure A is fed to the reactor at a concentration of 2 mol/Liter. Using the segregated model, the percentage conversion in the reactor is _____ (rounded off to the nearest integer).

(2-Marks)

4. A first-order irreversible liquid phase reaction $A \rightarrow B$ ($k = 0.1 \text{ min}^{-1}$) is carried out under isothermal, steady state conditions in the following reactor arrangement comprising an ideal CSTR (Continuous-Stirred Tank Reactor) and two ideal PFRs (Plug Flow Reactors). From the information in the figure, the volume of the CSTR (in Liters) is _____ (rounded off to the nearest integer).

(2-Marks)

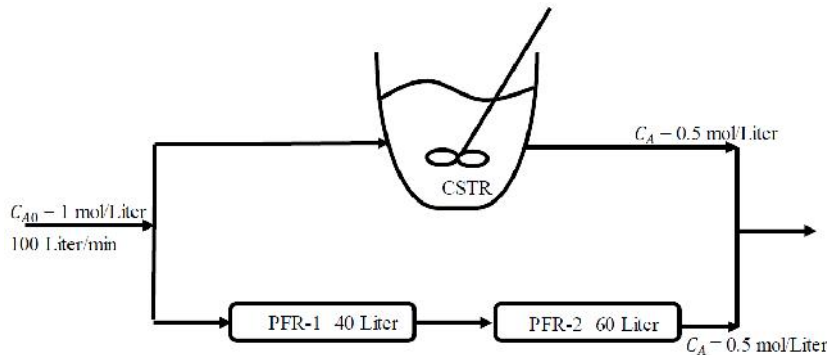

5. The elementary liquid-phase irreversible reactions

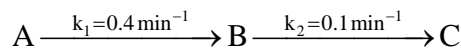

Take place in an isothermal ideal CSTR (Continuous-Stirred Tank Reactor). Pure A is fed to the reactor at a concentration of 2 mol/Liter. For the residence time that maximizes the exit

concentration of B, the percentage yield of B, defined as $\left(\frac{\text{net formation rate of B}}{\text{consumption rate of A}} \times 100 \right)$, is

_____ (rounded off to the nearest integer)

(2-Marks)

6. The elementary irreversible gas-phase reaction $A \rightarrow B + C$ is carried out adiabatically in an ideal CSTR (Continuous-Stirred Tank Reactor) operating at 10 atm. Pure A enters the CSTR at a flow rate of 10 mol/s and a temperature of 450 K. Assume A, B and C to be ideal gases. The specific heat capacity at constant pressure (C_{p_i}) and heat of formation (H_i^0), of component i ($i = A, B, C$), are

(2-Marks)

$$C_{pA} = 30 \text{ J/(mol K)} \quad C_{pB} = 10 \text{ J/(mol K)} \quad C_{pC} = 20 \text{ J/(mol K)}$$

$$H_A^0 = -90 \text{ kJ/mol} \quad H_B^0 = -54 \text{ kJ/mol} \quad H_C^0 = -45 \text{ kJ/mol}$$

The reaction rate constant k (per second) = $0.133 \exp \left\{ \frac{E}{R} \left(\frac{1}{450} - \frac{1}{T} \right) \right\}$, where

$E = 31.4$ kJ/mol and universal gas constant $R = 0.082$ L atm/(mol K) = 8.314 J/(mol K). The shaft work may be neglected in the analysis, and specific heat capacities do not vary with temperature. All heats of formation are referenced to 273 K. The reactor volume (in Liters) for 75% conversion is _____ (rounded off to the nearest integer).

GATE-2018

7. Liquid phase isomerisation of o-xylene to p-xylene using a zeolite catalyst was carried out in a CSTR. Three sets of kinetic data at different temperatures and stirring speeds were obtained as shown below.

	Set-A			Set-B			Set-C		
Temperature (K)	500	500	500	600	600	600	700	700	700
Stirring speed (rpm)	1000	2000	3000	1000	2000	3000	1000	2000	3000
Reaction rate ($\text{mol L}^{-1} \text{s}^{-1}$)	0.020	0.025	0.025	0.037	0.047	0.047	0.069	0.078	0.086

The operating condition at which the reaction rate is not controlled by external mass transfer resistance is

(1-Mark)

- (A) $T = 500 \text{ K}$; rpm = 3000
 (B) $T = 600 \text{ K}$; rpm = 1000
 (C) $T = 700 \text{ K}$; rpm = 1000
 (D) $T = 700 \text{ K}$; rpm = 2000
8. For a chemical reaction, the ratio of rate constant at 500 K to that at 400 K is 2.5. Given $R = 8.314 \text{ J mol}^{-1} \text{ K}^{-1}$, the value of activation energy (in kJ/mol) is (1-Mark)
- (A) 10.5 (B) 12.0 (C) 15.2 (D) 18.4
9. A CSTR and a PFR of equal volume are connected in series as shown below to carry out a first-order, isothermal, liquid phase reaction (2-Mark)

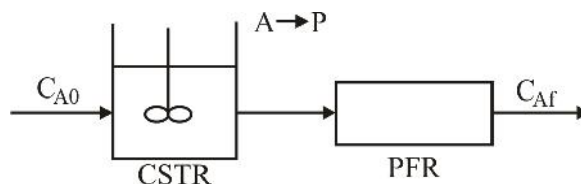

The rate constant is 0.2 s^{-1} . The space-time is 5 s for both the reactors. The overall fractional conversion of A is _____ (rounded off to third decimal place).

10. The elementary second-order liquid phase reaction $A + B \rightarrow C + D$ is carried out in an isothermal plug flow reactor of 2 m^3 volume. The inlet volumetric flow rate is $10 \text{ m}^3/\text{h}$. The initial concentrations of both A and B are 2 kmol/m^3 . The rate constant is given as $2.5 \text{ m}^3 \text{ kmol}^{-1} \text{ h}^{-1}$. The percentage conversion of A is _____ (2-Marks)
11. A set of standard stainless steel pipes, each of internal diameter 26.65 mm and 6000 mm length, is used to make a plug flow reactor by joining them in series to carry out degradation of polyethylene. Seven such pipes are required to obtain a conversion of 66% at 450 K. The minimum number of standard 8000 mm long pipes of the same internal diameter to be procured for obtaining at least 66% conversion under the same reaction conditions is _____ (2-Marks)
12. Hydrogenation of benzene is to be carried out using Ni (density = 8910 kg/m^3) as catalyst, cast in the form of non-porous hollow cylinders, as shown below. The reaction occurs on all the surface of the hollow cylinder. During an experiment, one such cylinder is suspended in the reactant stream. If the observed rate of reaction is $0.39 \text{ mol (m}^2 \text{ of catalyst surface)}^{-1} \text{ min}^{-1}$, then the rate of reaction in $\text{mol (kg of catalyst)}^{-1} \text{ min}^{-1}$ is _____ (rounded off of three decimal places). (2-Marks)

ANSWER KEY

1	2	3	4	5	6	7	8	9	10
C	D	64.64	855.7	67	133.27	A	C	0.81	50
11	12	13	14	15	16	17	18	19	20
6	0.035	0.4	A	B	C	0.60	1	0.8	4
21	22	23	24	25	26	27	28	29	30
20.4	2	C	28.5	0.26671	8	B	0.25	B	A
31	32	33	34	35	36	37	38	39	40
B	A	C	0.801	A	D	B	C	D	0.5
41	42	43	44	45	46	47	48	49	50
0.32	0.50	1.0	51.7	20.0	90%	D	D	B	B
51	52	53	54	55	56	57	58	59	60
C	B	C	A	B	A	B	C	B	D
61	62	63	64	65	66	67	68	69	70
A	A	B	C	A	C	C	C	D	B
71	72	73	74	75	76	77	78	79	80
B	A	C	A	C	D	B	A	C	C
81	82	83	84	85	86	87	88	89	90
B	C	B	C	B	A	B	B	A	A
91	92	93	94	95	96	97	98	99	100
A	C	D	D	B	D	C	D	B	D
101	102	103	104	105	106	107	108	109	110
A	C	A	B	D	A	C	A	C	A
111	112	113	114	115	116	117	118	119	120
B	A	D	C	C	d	C	C	A	B
121	122	123	124	125	126	127	128	129	130
B	B	B	D	A	B	C	D	C	D
131	132	133	134	135	136	137	138	139	140
D	A	B	D	B	D	B	C	B	B
141	142	143	144	145	146	147	148	149	150
B	A	A	C	A	C	A	C	B	C
151	152	153							
A	C	D							

2. HEAT TRANSFER (GATE Previous Papers)

GATE-2019

1. Prandtl number signifies the ratio of (1-Mark)

- | | |
|--|--|
| (a) $\frac{\text{Momentum diffusivity}}{\text{Thermal diffusivity}}$ | (b) $\frac{\text{Mass diffusivity}}{\text{Thermal diffusivity}}$ |
| (c) $\frac{\text{Thermal diffusivity}}{\text{Momentum diffusivity}}$ | (d) $\frac{\text{Thermal diffusivity}}{\text{Mass diffusivity}}$ |

2. Pool boiling equipment operating above ambient temperature is usually designed to operate (1-Mark)

- | | |
|--------------------------------------|---------------------------------|
| (a) far above the critical heat flux | (b) near the critical heat flux |
| (c) far above the Leidenfrost point | (d) near the Leidenfrost point |

3. Consider the two countercurrent heat exchanger designs for heating a cold stream from t_{in} to t_{out} , as shown in figure. The hot process stream is available at T_{in} . The inlet stream conditions and overall heat transfer coefficients are identical in both the designs. The heat transfer area in Design I and Design II are respectively A_{HX}^I and A_{HX}^{II} . (1-Mark)

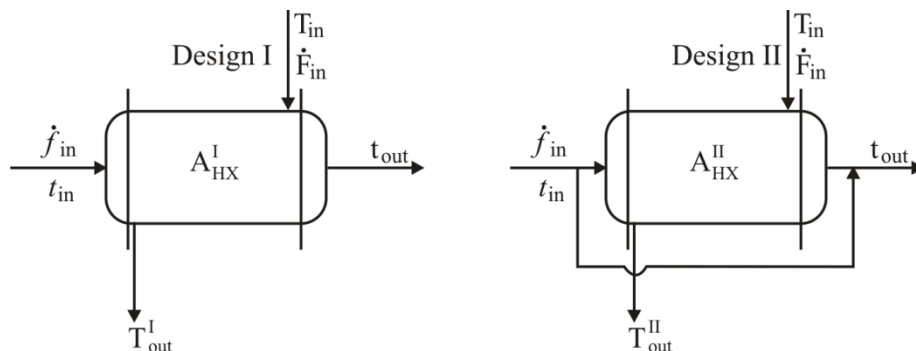

If heat losses are neglected, and if both the designs are feasible, which of the following statements holds true?

- | | |
|---|---|
| (a) $A_{HX}^I > A_{HX}^{II}$ $T_{out}^I < T_{out}^{II}$ | (b) $A_{HX}^I = A_{HX}^{II}$ $T_{out}^I = T_{out}^{II}$ |
| (c) $A_{HX}^I < A_{HX}^{II}$ $T_{out}^I > T_{out}^{II}$ | (d) $A_{HX}^I < A_{HX}^{II}$ $T_{out}^I = T_{out}^{II}$ |
4. A solid sphere of radius 1 cm and initial temperature of 25 °C is exposed to a gas stream at 100 °C. For the solid sphere, the density is 10^4 kg/m³ and the specific heat capacity is 500 J/(kg K). The density of the gas is 0.6 kg/m³ and its specific heat capacity is 10^3 J/(kg K). The solid sphere is approximated as a lumped system (Biot number $\ll 1$) and all specific heats are constant. If the heat transfer coefficient between the solid and gas is 50 W/(m² K), the time (in seconds) needed for the sphere to reach 95°C is _____ (rounded off to the nearest integer) (2-Marks)

5. Stream A with specific heat capacity $C_{pA} = 2000 \text{ J/(kg K)}$ is cooled from 90°C to 45°C in a concentric double pipe counter current heat exchanger having a heat transfer area of 8 m^2 . The cold stream B of specific heat capacity $C_{pB} = 1000 \text{ J/(kg K)}$ enters the exchanger at a flow rate 1 kg/s and 40°C . The overall heat transfer coefficient $U = 250 \text{ W/(m}^2 \text{ K)}$. Assume that the mean driving force is based on the arithmetic mean temperature difference, that is
- $$[\Delta T]_{\text{AMTD}} = \left(\frac{T_{A,\text{in}} + T_{A,\text{out}}}{2} \right) - \left(\frac{T_{B,\text{in}} + T_{B,\text{out}}}{2} \right)$$
- where $T_{i,\text{in}}$ and $T_{i,\text{out}}$ refer to the temperature of the i^{th} stream ($i = A, B$) at the inlet and exit, respectively. The mass flow rate of stream A (in kg/s), is _____ (rounded off to two decimal places)

(2-Marks)

6. A 20 cm diameter cylindrical solid pellet of a nuclear fuel with density 6000 kg/m^3 and conductivity of 300 W/(m K) generates heat by nuclear fission at a spatially uniform rate of 10^4 W/kg . The heat from the fuel pellet is transferred to the surrounding coolant by convection such that the pellet wall temperature remains constant at 300°C . Neglecting the axial and azimuthal dependence, the maximum temperature (in $^\circ\text{C}$) in the pellet at steady state is _____ (rounded off to the nearest integer).

(2-Marks)

GATE-2018

7. Economy of evaporators used for concentrating sugarcane juice is (1-Mark)
- | | |
|--|---|
| (A) $\frac{\text{kg of concentrated juice produced}}{\text{kg of steam supplied}}$ | (B) $\frac{\text{kg of steam supplied}}{\text{kg of sugarcane juice fed}}$ |
| (C) $\frac{\text{kg of water vaporized}}{\text{kg of steam supplied}}$ | (D) $\frac{\text{kg of sugarcane juice fed}}{\text{kg of water vaporized}}$ |
8. Segmental baffles in a 2-4 shell and tube heat exchanger (1-Mark)
- (A) Change the flow pattern of the tube side fluid and increase the overall heat transfer coefficient
- (B) Increase the heat transfer coefficient in the shell side and support the tubes
- (C) Help to reduce the thermal expansion of the tubes and increase the heat transfer coefficient in the tube side
- (D) Increase the number of passes in the shell side and increase the heat transfer coefficient in the tube side
9. An insulated storage tank contains 1000 kg liquid of specific heat $10 \text{ kJ kg}^{-1} \text{ K}^{-1}$. The liquid is heated by saturated steam, condensing in a helical coil at a temperature of 180°C . The heat transfer area of the coil is 0.1 m^2 . If the overall heat transfer coefficient is constant at $1000 \text{ W m}^{-2} \text{ K}^{-1}$, then the time (in hours) required to raise the temperature of the liquid in the tank from 20°C to 80°C is _____ (rounded off to second decimal place) (2-Marks)
10. The wall of a pipe of radius 1 m is at a uniform temperature of 200°C , and is covered by insulation of thickness 0.1 m . The ambient air outside the insulated pipe is at 20°C and has heat transfer coefficient of $10 \text{ W m}^{-2} \text{ K}^{-1}$. The thermal conductivity of the insulation material is $0.05 \text{ W m}^{-1} \text{ K}^{-1}$. If the heat transfer occurs at steady state, the temperature (in $^\circ\text{C}$) of the outer surface of insulation is _____ (rounded off to second decimal place). (2-Marks)

122. A steel sphere of radius 0.1 m at 400 K is immersed in an oil at 300 K. If the centre of the sphere reaches 350 K in 20 minutes, how long will it take for a 0.05 m radius steel sphere to reach the same temperature (at the centre) under identical conditions? Assume that the convective heat transfer coefficient is infinitely large. (2-Marks)
 (A) 5 min (B) 10 min (C) 20 min (D) 40 min
123. A composite flat wall of a furnace is made of two materials A and B. The thermal conductivity of A is twice of that of material B, while the thickness of layer of A is half of that of B if the temperatures at the two sides of the wall are 400 and 1200 K, then the temperature drop (in K) across the layer of material A is (2-Marks)
 (A) 125 (B) 133 (C) 150 (D) 160
124. For turbulent flow in a tube, the heat transfer coefficient is obtained from the Dittus-Boelter correlation. If the tube diameter is halved and the flow rate is doubled, then heat transfer coefficient will change by a factor of (2-Marks)
 (A) 1 (B) 1.74 (C) 6.1 (D) 37

ANSWER KEY: HEAT TRANSFER

1	2	3	4	5	6	7	8	9	10
A	B	D	902.68	0.305	800	C	B	13.06	28.2°C
11	12	13	14	15	16	17	18	19	20
0.52	27.0	B	300	C	C	B	3.9	C	D
21	22	23	24	25	26	27	28	29	30
B	A	0.25	A	A	250.9	C	C	A	D
31	32	33	34	35	36	37	38	39	40
17.14	3.85	271.07°C	D	D	5.67	C	D	D	B
41	42	43	44	45	46	47	48	49	50
D	A	B	B	B	A	B	A	A	A
51	52	53	54	55	56	57	58	59	60
B	A	A	D	B	A	B	B	C	B
61	62	63	64	65	66	67	68	69	70
A	D	D	B	B	D	B	B	D	C
71	72	73	74	75	76	77	78	79	80
B	B	A	D	B	A	C	D	B	A
81	82	83	84	85	86	87	88	89	90
D	D	A	D	B	B	C	D	B	C
91	92	93	94	95	96	97	98	99	100
A	C	A	C	B	A	A	D	D	A
101	102	103	104	105	106	107	108	109	110
A	B	A	B	D	A	A	D	B	B
111	112	113	114	115	116	117	118	119	120
D	D	A	D	C	B	B	B	C	C
121	122	123	124						
D	A	D	C						

3. MASS TRANSFER

(GATE Previous Papers)

GATE-2019

- The correct expression for the Colburn j-factor for mass transfer that relates Sherwood number (Sh), Reynolds number (Re) and Schmidt number (Sc) is (1-Mark)
 - $\frac{Sh}{(Re)(Sc)^{1/3}}$
 - $\frac{Sh}{(Re)^{1/2}(Sc)}$
 - $\frac{Sh}{(Re)^{1/2}(Sc)^{1/3}}$
 - $\frac{Sh}{(Re)(Sc)}$
- In the drying of non-dissolving solids at constant drying conditions, the internal movement of moisture in the solid has a dominant effect on the drying rate during (1-Mark)
 - the initial adjustment period only
 - the constant rate period only
 - the falling rate period only
 - both the initial adjustment and constant rate periods
- Three distillation schemes for separating an equimolar, constant relative volatility ABC mixture into nearly pure components are shown. The usual simplifying assumptions such as constant molal overflow, negligible heat loss, ideal trays are valid. All the schemes are designed for minimum total reboiler duty. Given that the relative volatilities are in the ratio $\alpha_A : \alpha_B : \alpha_C = 8 : 2 : 1$, the correct option that arranges the optimally-designed schemes in ascending order of total reboiler duty is (1-Mark)

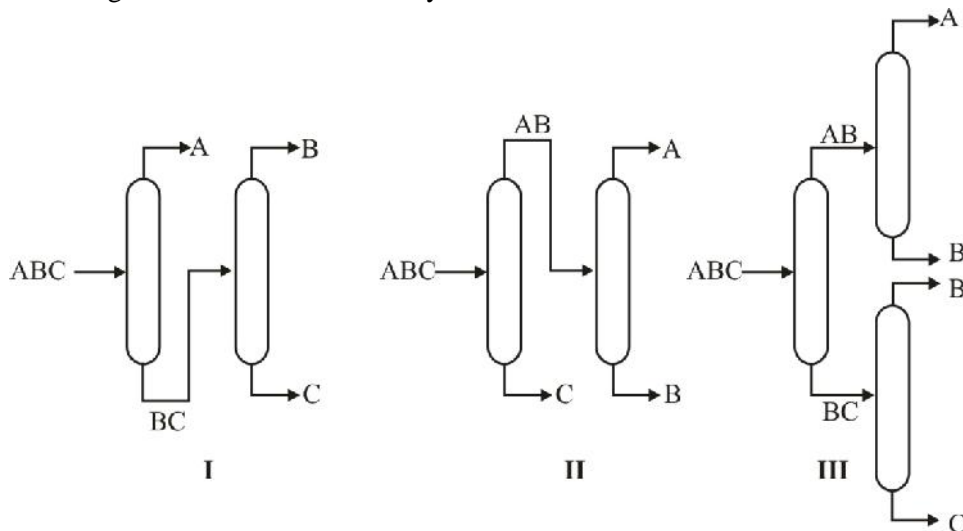

- I, II, III
- III, I, II
- II, I, III
- III, II, I

- Consider a sealed rigid bottle containing CO_2 and H_2O at 10 bar and ambient temperature. Assume that the gas phase in the bottle is pure CO_2 and follows the ideal gas law. The liquid phase in the bottle contains CO_2 dissolved in H_2O and is an ideal solution. The Henry's constant at the system pressure and temperature is $H_{\text{CO}_2} = 1000$ bar. The equilibrium mole fraction of CO_2 dissolved in H_2O is _____ (rounded off to three decimal places). (1-Mark)

149. In a laboratory test run, the rate of drying was found to be $0.5 \times 10^{-3} \text{kg/m}^2 \text{ s}$ when the moisture content reduced from 0.4 to 0.1 on a dry basis. The critical moisture content of the material is 0.08 on a dry basis. A ray drier is used to dry 100kg (dry basis) of the same material under identical conditions. The surface area of the material is $0.04 \text{ m}^2/\text{kg}$ of dry solid. The time required (*in seconds*) to reduce the moisture content of the solids from 0.3 to 0.2 (*dry basis*) is (2-Marks)
- (A) 2000 (B) 4000 (C) 5000 (D) 6000

ANSWER KEY

1	2	3	4	5	6	7	8	9	10
A	C	B	0.01	C	8	0.005	1.647	D	B
11	12	13	14	15	16	17	18	19	20
D	3.84	0.67	11.11	1	124.25	D	120	B	0.897
21	22	23	24	25	26	27	28	29	30
B	4	13.33	0.396	C	1	C	C	B	D
31	32	33	34	35	36	37	38	39	40
1.1	1.02	C	B	0.22	1.4	6.4	D	C	A
41	42	43	44	45	46	47	48	49	50
B	B	1.21	3.75	B	D	66.85	A	1.14	A
51	52	53	54	55	56	57	58	59	60
C	B	B	C	C	B	B	A	D	B
61	62	63	64	65	66	67	68	69	70
D	D	B	D	A	A	A	D	D	A
71	72	73	74	75	76	77	78	79	80
D	C	C	D	B	A	A	A	B	B
81	82	83	84	85	86	87	88	89	90
D	A	A	A	C	C	B	B	B	B
91	92	93	94	95	96	97	98	99	100
B	C	C	A	A	A	C	B	D	C
101	102	103	104	105	106	107	108	109	110
C	A	A	A	B	C	D	A	D	C
111	112	113	114	115	116	117	118	119	120
A	D	A	C	B	D	C	B	C	C
121	122	123	124	125	126	127	128	129	130
D	D	C	D	B	B	A	B	C	D
131	132	133	134	135	136	137	138	139	140
D	B	D	C	A	C	C	C	A	C
141	142	143	144	145	146	147	148	149	
B	C	B	A	B	B	C	D	C	

4. INSTRUMENTATION & PROCESS CONTROL (GATE Previous Papers)

GATE-2019

1. A thermocouple senses temperature based on the (1-Mark)
(A) Nernst Effect (B) Maxwell Effect (C) Seebeck Effect (D) Peltier Effect

2. The liquid flow rate through an equal percentage control valve, when fully open, is 150 gal/min and the corresponding pressure drop is 50 psi. If the specific gravity of the liquid is 0.8, then the valve coefficient, C_v , in gal/(min psi^{0.5}) is _____ (rounded off to two decimal places). (1-Mark)

3. Consider two non-interacting tanks-in-series as shown in figure. Water enters TANK 1 at q cm³/s and drains down to TANK 2 by gravity at a rate $k\sqrt{h_1}$ (cm³/s). Similarly, water drains from TANK 2 by gravity at a rate of $k\sqrt{h_2}$ (cm³/s) where h_1 and h_2 represent levels of TANK 1 and TANK 2, respectively (see figure). Drain valve constant $k = 4$ cm^{2.5}/s and cross-sectional areas of the two tanks are $A_1 = A_2 = 28$ cm². (2-Marks)

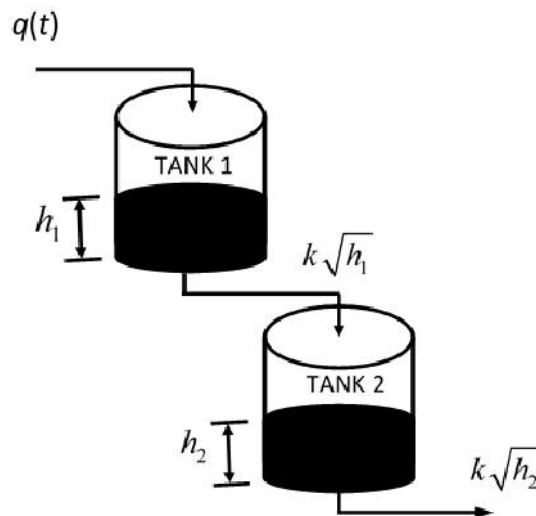



At steady state operation, the water inlet flow rate is $q_{ss} = 16$ cm³/s. The transfer function relating the deviation variables \tilde{h}_2 (cm) to flow rate \tilde{q} (cm³/s) is (2-Marks)

- (A) $\frac{2}{(56s+1)^2}$ (B) $\frac{2}{(62s+1)^2}$ (C) $\frac{2}{(36s+1)^2}$ (D) $\frac{2}{(49s+1)^2}$

4. Choose the option that correctly matches the step response curves on the left with the appropriate transfer functions on the right. The step input change occurs at time $t = 0$

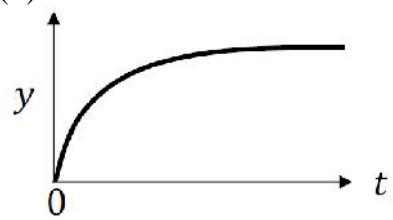
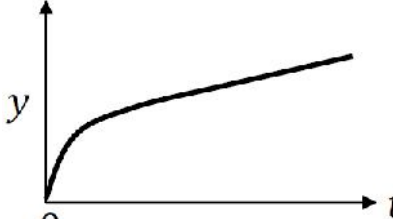
(2-Marks)

Step response	Transfer function
(P) 	(I) $\frac{K(\xi s + 1)}{s(\tau s + 1)}$ $K > 0, \xi > 0, \tau > 0$
(Q) 	(II) $\frac{K(\xi s + 1)}{(\tau s + 1)}$ $K > 0, \xi > \tau > 0$
(R) 	(III) $\frac{K}{(\tau s + 1)}$ $K > 0, \tau > 0$
(S) 	(IV) $\frac{K(\xi s + 1)}{(\tau_1 s + 1)(\tau_2 s + 1)}$ $K > 0, \xi < 0$ $\tau_1 > 0, \tau_2 > 0$

- (A) P - III, Q - IV; R - II, S - I
(C) P - IV, Q - III; R - II, S - I

- (B) P - III, Q - I; R - IV, S - II
(D) P - III, Q - II; R - IV, S - I

5. For the closed loop system shown in figure, the phase margin (in degrees) is _____ (rounded off to one decimal place)

(2-Marks)

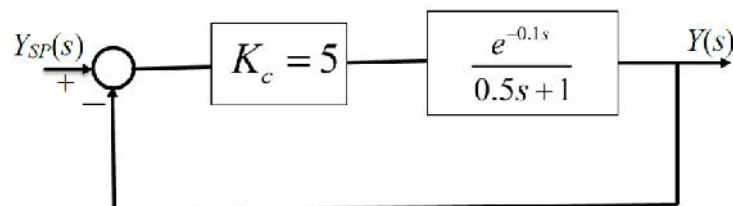

(D) poles of the closed loop transfer function should lie in the right half of the complex plane.

121. The initial value ($t = 0^+$) of the unit step response of the transfer function $[(s+1) / (2s + 1)]$ is
 (A) 0 (B) $\frac{1}{2}$ (C) 1 (D) 2
122. The time constant of a unity gain, first order plus time delay process is 5 min. if the phase lag at a frequency of 0.2 rad/min is 60° , then the dead time (in minutes) is
 (A) $\frac{5\pi}{12}$ (B.) $\frac{\pi}{6}$ (C) $\frac{\pi}{12}$ (D) $\frac{\pi}{3}$



ANSWER KEY

1	2	3	4	5	6	7	8	9	10
C	18.97	A	B	45.4	C	C	D	0.41 to 0.42	0.2
11	12	13	14	15	16	17	18	19	20
C	A	B	0.3725	0.785	10	D	C	D	10.124
21	22	23	24	25	26	27	28	29	30
2.5	15.87	C	D	5.03	0.87	A	C	D	C
31	32	33	34	35	36	37	38	39	40
16.3	C	D	0.50	A	1.4787	C	B	D	A
41	42	43	44	45	46	47	48	49	50
C	C	C	C	B	D	C	B	C	C
51	52	53	54	55	56	57	58	59	60
C	B	D	B	D	D	A	A	A	D
61	62	63	64	65	66	67	68	69	70
A	C	C	B	D	A	D	B	C	D
71	72	73	74	75	76	77	78	79	80
A	A	B	C	A	D	A	A	C	D
81	82	83	84	85	86	87	88	89	90
C	A	D	A	A	D	A	B	C	B
91	92	93	94	95	96	97	98	99	100
C	B	C	D	D	D	C	A	C	C
101	102	103	104	105	106	107	108	109	110
A	A	B	A	D	A	B	C	C	C
111	112	113	114	115	116	117	118	119	120
D	A	B	D	C	A	C	B	C	B
121	122								
B	A								

SOLUTIONS

GATE-2019

1. (C)

A Thermocouple is an electrical device consisting of two dissimilar electrical conductors forming electrical junctions at different temperature and produces a thermo emf (mV), which can be interpreted to measure temperature.

2. (18.97) The liquid flow rate, $Q = C_v \cdot f(x) \sqrt{\frac{\Delta P}{S.g}}$

Where, S.g = Specific gravity,

for equal percentage control valve, $f(x) = R^{x-1}$ for (at fully open) $x = 1.0$, $f(x) = 1.0$

$$\Rightarrow 150 = C_v \times 1 \times \sqrt{\frac{50}{0.8}} = 18.97 \frac{\text{gal}}{(\text{min psi}^{0.5})}$$

3. (A)

$$k = 4, A_1 = A_2 = 28 \text{ m}^2$$

The water inlet flow rate, $q_{ss} = 16 \text{ cm}^3/\text{sec}$

$$\Rightarrow 16 = 4\sqrt{h_{1,s}}$$

Height of water in tank at initial steady state condition, $h_{1,s} = 16 \text{ cm}$

$$\text{Resistance } (R_1 = R_2) = \frac{2\sqrt{16}}{4} = 2$$

$$\frac{\bar{Q}_1(s)}{\bar{Q}(s)} = \frac{1}{28 \times 2s + 1} = \frac{1}{(56s + 1)} \quad \dots(1)$$

$$\frac{\bar{H}_2(s)}{\bar{Q}_1(s)} = \frac{R_2}{(28 \times R_2s + 1)} = \frac{2}{(56s + 1)} \quad \dots(2)$$

Multiplying equation (1) and (2)

$$\text{The transfer function} = \frac{\bar{H}_2(s)}{\bar{Q}(s)} = \frac{2}{(56s + 1)^2}$$

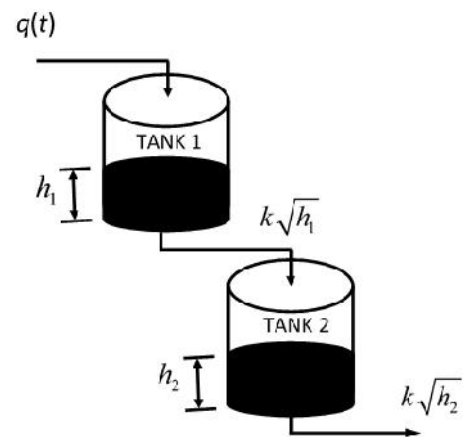

4. (B)

<p>(P)</p>	<p>(III) $\frac{K}{(\tau s + 1)}$ $K > 0, \tau > 0$</p> <p>Initial value = 0</p> <p>Final value of step response = $y(\infty) = K$</p>
<p>(Q)</p>	<p>(I) $\frac{K(\xi s + 1)}{s(\tau s + 1)}$ $K > 0, \xi > 0, \tau > 0$</p>

5. THERMODYNAMICS (GATE Previous Papers)

GATE-2019

1. Consider a rigid, perfectly insulated, container partitioned into two unequal parts by a thin membrane (see figure). One part contains one mole of an ideal gas at pressure P_i and temperature T_i while the other part is evacuated. The membrane ruptures, the gas fills the entire volume and the equilibrium pressure is $P_f = P_i/4$. If C_p (molar specific heat capacity at constant pressure), C_v (molar specific heat capacity at constant volume) and R (universal gas constant) have the same units as molar entropy, the change in molar entropy ($S_f - S_i$) is

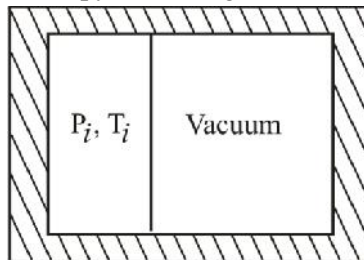

- (1-Mark)**
- (A) $C_p \ln 2 + R \ln 4$ (B) $-C_v \ln 2 + R \ln 4$ (C) $R \ln 4$ (D) $C_p \ln 2$
2. For a single component system, vapor (subscript g) and liquid (subscript f) coexist in mechanical, thermal and phase equilibrium when **(1-Mark)**
- (A) $u_g = u_f$ (equality of specific internal energy)
 (B) $h_g = h_f$ (equality of specific enthalpy)
 (C) $s_g = s_f$ (equality of specific entropy)
 (D) $g_g = g_f$ (equality of specific Gibbs free energy)
3. For a binary nonideal A-B mixture exhibiting a minimum boiling azeotrope, the activity coefficients, γ_i ($i = A, B$), must satisfy **(1-Mark)**
- (A) $\gamma_A > 1, \gamma_B > 1$ (B) $\gamma_A < 1, \gamma_B > 1$
 (C) $\gamma_A = 1, \gamma_B = 1$ (D) $\gamma_A < 1, \gamma_B < 1$
4. Carbon monoxide (CO) reacts with hydrogen sulphide (H_2S) at a constant temperature of 800 K and a constant pressure of 2 bar as: **(2-Marks)**

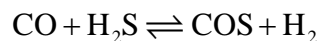

The Gibbs free energy of the reaction $\Delta g^\circ_{rxn} = 22972.3 \text{ J/mol}$ and universal gas constant $R = 8.314 \text{ J/(mol K)}$. Both the reactants and products can be assumed to be ideal gases. If initially only 4 mol of H_2S and 1 mol of CO are present, the extent of the reaction (in mol) at equilibrium is _____ (rounded off to two decimal places)

5. For a given binary system at constant temperature and pressure, the molar volume (in m^3/mol) is given by: $v = 30x_A + 20x_B + x_A x_B (15x_A - 7x_B)$, where x_A and x_B are the mole fractions of components A and B, respectively. The volume change of mixing Δv_{mix} (in m^3/mol) at $x_A = 0.5$ is _____ (rounded off to one decimal place) **(2-Marks)**

6. Consider a vessel containing steam at 180 °C. The initial steam quality is 0.5 and the initial volume of the vessel is 1 m³. The vessel loses heat at a constant rate \dot{q} under isobaric conditions so that the quality of steam reduces to 0.1 after 10 hours. The thermodynamic properties of water at 180 °C are (subscript g: vapor phase; subscript f: liquid phase):

specific volume: $v_g = 0.19405 \text{ m}^3/\text{kg}$, $v_f = 0.001127 \text{ m}^3/\text{kg}$; (2-Marks)
 specific internal energy: $u_g = 2583.7 \text{ kJ/kg}$, $u_f = 762.08 \text{ kJ/kg}$;
 specific enthalpy: $h_g = 2778.2 \text{ kJ/kg}$, $h_f = 763.21 \text{ kJ/kg}$.

The rate of heat loss \dot{q} (in kJ/hour) is _____ (rounded off to the nearest integer).

7. A fractionator recovers 95 mol % n-propane as the distillate from an equimolar mixture of n-propane and n-butane. The condensate is a saturated liquid at 55°C. The Antoine equation is

of the form, $\ln(P^{\text{sat}}[\text{in bar}]) = A - \frac{B}{T[\text{in K}] + C}$, and the constants are provided below:

	A	B	C
n-propane	9.1058	1872.46	-25.16
n-butane	9.0580	2154.90	-34.42

Assuming Raoult's law, the condenser pressure (in bar) is ____ (rounded off to onedecimal place). (2-Marks)

GATE-2018

8. Consider the following properties:

(P) temperature (Q) specific gravity
 (R) chemical potential (S) volume

The option which lists ALL the intensive properties is (1-Mark)

(A) P (B) P and Q (C) P, Q and R (D) P, Q, R and S

9. G denotes the Gibbs free energy of a binary mixture, n_T denotes the total number of moles present in the system, μ_i is the chemical potential of i^{th} component ($\mu_1 \neq 0$ & $\mu_1 > \mu_2$) and x_i

is the mole fraction of the i^{th} component. The correct variation of $\frac{G}{n_T}$ (in J/mol) at constant temperature and pressure is given by (2-Marks)

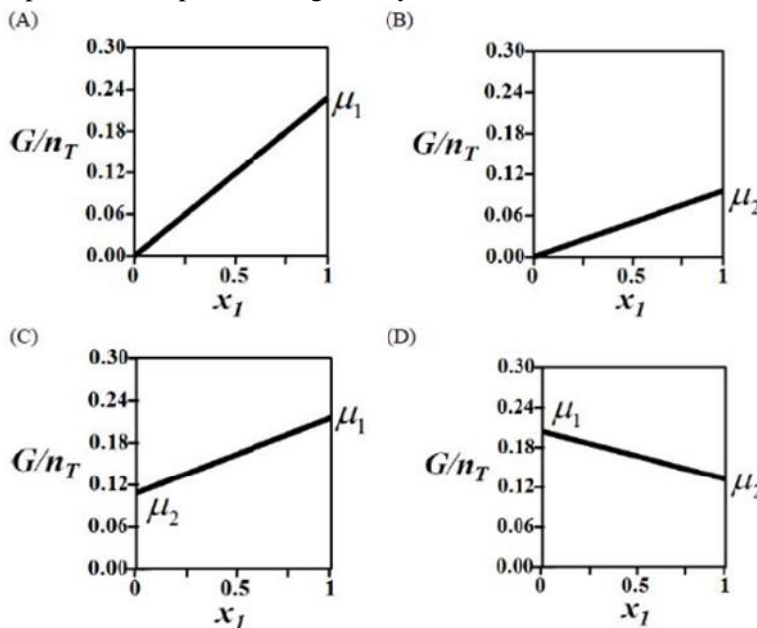

126. At a given temperature, K_1 , K_2 and K_3 are the equilibrium constants for the following reactions 1, 2, 3 respectively: (2-Marks)

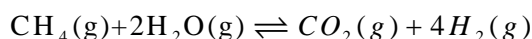
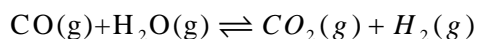
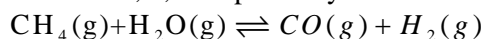

Then K_1 , K_2 and K_3 are related as

- (A) $K_3 = K_1 K_2$ (B) $K_3 = (K_1 K_2)^{0.5}$ (C) $K_3 = \frac{(K_1 + K_2)}{2}$ (D) $K_3 = (K_1 K_2)^2$

ANSWERS KEY

1	2	3	4	5	6	7	8	9	10
C	D	A	0.288	1	826	17.939	C	C	368.1
11	12	13	14	15	16	17	18	19	20
102.37	C	D	2450	0.91	14.49	-58	373	400	1.64
21	22	23	24	25	26	27	28	29	30
D	B	A	D	310	750	D	27.54	B	D
31	32	33	34	35	36	37	38	39	40
C	D	0.6965	3	C	D	B	B	0.0736	A
41	42	43	44	45	46	47	48	49	50
A	A	A	D	C	B	D	B	C	D
51	52	53	54	55	56	57	58	59	60
C	C	A	B	B	C	D	C	D	B
61	62	63	64	65	66	67	68	69	70
B	B	C	B	A	D	A	B	A	C
71	72	73	74	75	76	77	78	79	80
C	D	B	C	D	C	B	B	B	D
81	82	83	84	85	86	87	88	89	90
C	B	B	A	C	D	B	A	B	D
91	92	93	94	95	96	97	98	99	100
A	B	C	B	B	D	A	D	C	A
101	102	103	104	105	106	107	108	109	110
C	A	D	B	B	C	D	A	B	C
111	112	113	114	115	116	117	118	119	120
C	B	A	D	B	B	A	B	D	A
121	122	123	124	125	126				
A	A	B	C	C	A				

6. FLUID MECHANICS (GATE Previous Papers)

GATE-2019

- For a fully-developed turbulent hydrodynamic boundary layer for flow past a flat plate, the thickness of the boundary layer increases with distance x from the leading edge of the plate, along the free-stream flow direction, as **(1-Mark)**
 (A) $x^{0.5}$ (B) $x^{1.5}$ (C) $x^{0.4}$ (D) $x^{0.8}$
- For a hydraulic lift with dimensions shown in figure, assuming $g = 10 \text{ m/s}^2$, the maximum diameter D_{left} (in m) that lifts a vehicle of mass 1000 kg using a force of 100 N is _____ (rounded off to two decimal places). **(1-Mark)**

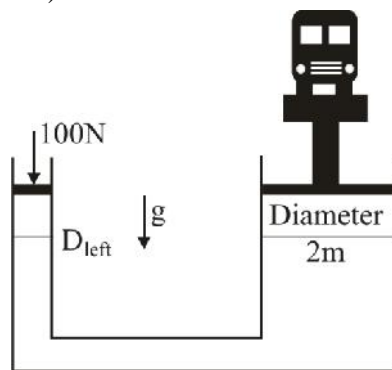

- An incompressible Newtonian fluid flows in a pipe of diameter D_1 at volumetric flow rate Q . Fluid with same properties flows in another pipe of diameter $D_2 = D_1/2$ at the same flow rate Q . The transition length required for achieving fully-developed flow is l_1 for the tube of diameter D_1 , while it is l_2 for the tube of diameter D_2 . Assuming steady laminar flow in both cases, the ratio l_1/l_2 is: **(2-Marks)**
 (A) $1/4$ (B) 1 (C) 2 (D) 4
- A centrifugal pump is used to pump water (density 1000 kg/m^3) from an inlet pressure of 10^5 Pa to an exit pressure of $2 \times 10^5 \text{ Pa}$. The exit is at an elevation of 10 m above the pump. The average velocity of the fluid is 10 m/s. The cross-sectional area of the pipes at the pump inlet and outlet is 10^{-3} m^2 and acceleration due to gravity is $g = 10 \text{ m/s}^2$. Neglecting losses in the system, the power (in Watts) delivered by the pump is _____ (rounded off to the nearest integer). **(2-Marks)**

GATE-2018

- Pitot tube is used to measure
 (A) liquid level in a tank (B) flow velocity at a point
 (C) angular deformation (D) vorticity **(1 Mark)**
- A venturimeter is installed to measure the flow rate of water in a 178 mm diameter (ID) pipe. Throat diameter is 102 mm. The differential pressure measured using a manometer is 154.3 kN/m^2 . The data given are:
 Discharge coefficient = 0.98; water density = 1000 kg/m^3
 The volumetric flow rate of water (in m^3/s) is _____. **(1-Mark)**

ANSWER KEY

1	2	3	4	5	6	7	8	9	10
d	0.2	b	2000	B	0.153	3.86	1	B	A
11	12	13	14	15	16	17	18	19	20
0.3125	C	C	10	B	48.9	0.125	C	1.64	C
21	22	23	24	25	26	27	28	29	30
25	C	D	8	8	A	80.8	B	A	D
31	32	33	34	35	36	37	38	39	40
C	B	137500	B	A	C	B	D	A	C
41	42	43	44	45	46	47	48	49	50
D	C	A	A	A	D	B	B	B	D
51	52	53	54	55	56	57	58	59	60
D	D	B	B	A	D	B	B	C	D
61	62	63	64	65	66	67	68	69	70
A	A	B	C	C	A	A	D	D	B
71	72	73	74	75	76	77	78	79	80
B	C	B	B	C	C	D	C	B	C
81	82	83	84	85	86	87	88	89	90
B	D	B	D	B	C	A	D	B	A
91	92	93	94	95	96	97	98	99	100
B	C	D	B	D	D	D	B	C	B
101	102	103	104	105	106	107	108	109	110
D	A	C	A	A	D	B	C	D	A
111	112								
B	D								

8. MECHANICAL OPERATIONS (GATE Previous Papers)

GATE-2019

1. Consider a cylinder (diameter D and length D), a sphere (diameter D) and a cube (side length D). Which of the following statements concerning the sphericity (ϕ) of the above objects is true: (1-Mark)
- (A) $\phi_{\text{sphere}} > \phi_{\text{cylinder}} > \phi_{\text{cube}}$ (B) $\phi_{\text{sphere}} = \phi_{\text{cylinder}} = \phi_{\text{cube}}$
 (C) $\phi_{\text{sphere}} < \phi_{\text{cylinder}} < \phi_{\text{cube}}$ (D) $\phi_{\text{sphere}} > \phi_{\text{cylinder}} = \phi_{\text{cube}}$
2. A disk turbine is used to stir a liquid in a baffled tank. To design the agitator, experiments are performed in a lab-scale model with a turbine diameter of 0.05 m and a turbine impeller speed of 600 rpm. The liquid viscosity is 0.001 Pa s while the liquid density is 1000 kg/m³. The actual application has a turbine diameter of 0.5 m, an impeller speed of 600 rpm, a liquid viscosity of 0.1 Pa s and a liquid density of 1000 kg/m³. The effect of gravity is negligible. If the power required in the lab-scale model is P_1 and the estimated power for the actual application is P_2 , then the ratio P_2/P_1 is (2-Marks)
- (A) 10^3 (B) 10^4 (C) 10^5 (D) 10^6

GATE-2018

3. The terminal velocity of a spherical particle in gravitational settling under Stokes' regime varies (1-Mark)
- (A) linearly with the particle diameter (B) linearly with the viscosity of the liquid
 (C) directly with the square of particle diameter (D) inversely with the density of particle
4. Critical speed of a ball mill depends on (1-Mark)
- (A) the radius of the mill (shell) and the radius of the particles
 (B) the radius of the mill (shell) and the density of the particles
 (C) the radius of the balls and the radius of the particles
 (D) the radius of the balls and the radius of the mill (shell)
5. Match the equipment in **Column A** with the corresponding process in **Column B**
- | Column A | Column B |
|------------------------|--------------------|
| (P) Centrifugal sifter | (I) Mixing |
| (Q) Bowl mill | (II) Sedimentation |
| (R) Gravity thickener | (III) Screening |
| (S) Two-arm kneader | (IV) Grinding |
- (A) P-I, Q-IV, R-II, S-III (B) P-III, Q-IV, R-II, S-I
 (C) P-IV, Q-I, R-II, S-III (D) P-IV, Q-III, R-I, S-II (2-Marks)
6. In a roll crusher, rolls of diameter 1 m each are set in such a manner that minimum clearance between the crushing surfaces is 15 mm. If the angle of nip is 31°, the maximum diameter of the particle (in mm) which can be crushed is _____ (rounded off to third decimal place). (2-Marks)

10. CHEMICAL TECHNOLOGY (GATE Previous Papers)

GATE-2019

1. Producer gas is obtained by (1-Mark)
 (A) passing air through red hot coke (B) thermal cracking of naphtha
 (C) passing steam through red hot coke (D) passing air and steam through red hot coke
2. In Kraft process, the essential chemical reagents used in the digester are (1-Mark)
 (A) caustic soda, mercaptans and ethylene oxide
 (B) caustic soda, sodium sulphide and soda ash
 (C) quick lime, salt cake and dimethyl sulphate
 (D) baking soda, sodium sulphide and mercaptans
3. The most common catalyst used for oxidation of o-xylene to phthalic anhydride is (1-Mark)
 (A) V_2O_5 (B) Pd (C) Pt (D) Ag
4. In petroleum refining operations, the process used for converting paraffins and naphthenes to aromatics is (1-Mark)
 (A) alkylation (B) catalytic reforming
 (C) hydrocracking (D) isomerisation
5. The combination that correctly matches the polymer in Group-1 with the polymerization reaction type in Group-2 is (1-Mark)
- | Group-1 | Group-2 |
|------------------|---------------------------------|
| P) Nylon 6 | I) Condensation polymerization |
| Q) Polypropylene | II) Ring opening polymerization |
| R) Polyester | III) Addition polymerization |
- (A) P-II, Q-I, R-III (B) P-I, Q-III, R-II (C) P-III, Q-II, R-I (D) P-II, Q-III, R-I

6. The combination that correctly matches the process in Group-1 with the entries in Group-2 is (2-Marks)

Group -I	Group -II
P) Wulff process	I) Sulfur mining
Q) Sulfitte process	II) Soda ash production
R) Solvay process	III) Acetylene production
S) Frasch process	IV) Pulp production

- (A) P-II, Q-IV, R-III, S-I (B) P-III, Q-IV, R-II, S-I
 (C) P-IV, Q-I, R-II, S-III (D) P-II, Q-I, R-IV, S-III

GATE-2018

7. In connection with petroleum refining, identify the **incorrect** statement among the following options. (1-Mark)
 (A) Desalting of crude oil is done before processing it in atmospheric distillation unit
 (B) A stream of hydrogen is produced in catalytic reforming of naphtha
 (C) Asphalt used for paving is a petroleum product
 (D) Cetane number indicates the quality of petrol / motor spirit

8. Polyvinyl chloride is produced by (1-Mark)
 (A) co-polymerization (B) addition-type kinetics
 (C) reacting chlorine with polyethylene (D) reacting hydrochloric acid with polyethylene
9. The molecular formula of the predominant chemical compound in commercial sugar is (1-Mark)
 (A) $C_{12}H_{22}O_{11}$ (B) $C_{12}H_{24}O_{12}$ (C) $C_6H_{10}O_5$ (D) $C_6H_{12}O_6$
10. Choose the correct statement (1-Mark)
 In viscose rayon manufacturing process,
 (A) carbon disulphide used as reactant for xanthate formation is regenerated in a later step
 (B) caustic soda used as reactant for steeping of cellulose is regenerated in a later step
 (C) sulphuric acid is used in steeping process of cellulose
 (D) the spun viscose rayon is hardened in an alkali bath

GATE-2017

11. The DCDA (Double Contact Double Absorption) process is used for the manufacture of (1-Mark)
 (A) urea (B) sulphuric acid (C) nitric acid (D) ammonia
12. Match the polymerization processes in Group-1 with the polymers in Group-2 (1-Mark)
- | Group-1 | Group-2 |
|----------------------------------|--------------------------|
| (P) Free radical polymerization | I) Nylon 6.6 |
| (Q) Ziegler Natta polymerization | II) Polypropylene |
| (R) Condensation polymerization | III) Poly vinyl chloride |
- Choose the correct set of combinations.
 (A) P-I Q-II R-III
 (B) P-III Q-II R-I
 (C) P-I Q-III R-II
 (D) P-II Q-I R-III
13. The purpose of methanation reaction used in ammonia plants is to (1-Mark)
 (A) remove CO as it is a catalyst poison
 (B) increase the amount of hydrogen
 (C) remove sulphur as it is a catalyst poison
 (D) utilize methane as a catalyst for ammonia synthesis
14. Match the equipment in Group-1 with the process in Group-2 (2-Marks)
- | Group-1 | Group-2 |
|--|----------------------------------|
| P) Fluidized bed | I) Paper-making |
| Q) Multistage adiabatic reactor with inter-stage cooling | II) Sodium hydroxide manufacture |
| R) Fourdrinier machine | III) SO_2 oxidation |
| S) Diaphragm cell | IV) Catalytic cracking |
- (A) P-IV Q-III R-I S-II
 (B) P-IV Q-III R-II S-I
 (C) P-III Q-IV R-I S-II
 (D) P-III Q-IV R-II S-I

CHEMICAL ENGINEERING

GATE-2020 SOLUTION



GATE-2020 Chemical Engineering

Subject	1-Marks	2-Marks	Total Marks
General Aptitude	5×1	5×2	10
Engg. Mathematics	5×1	4×2	13
Chemical Reaction Engineering	4×1	4×2	12
Mass Transfer	2×1	6×2	14
Process Dynamics and Control	2×1	2×2	6
Heat Transfer	2×1	4×2	10
Thermodynamics	2×1	3×2	8
Fluid Mechanics	1×1	4×2	9
Chemical Technology	4×1		4
Mechanical Operation	2×1	1×2	4
Plant Design Economic	1×1		1
Process Calculations		2×2	4
			Total = 100 Marks

Question 1 to 10 General Aptitude

(Question 1 to 5 (1-Mark) and 6 to 10 (2-Marks))

1. Rajiv Gandhi Khel Ratan Award was conferred _____ Mary Kom, a six-time world champion in boxing, recently in a ceremony _____ the Rashtrapati Bhawan (the President's official residence) in New Delhi.

(a) on, in (b) on, at (c) with, at (d) to, at

Answer: b

2. P, Q, R, S, T, U, V, and W are seated around a circular table.

I. S is seated opposite to W.

II. U is seated at the second place to the right of R.

III. T is seated at the third place to the left of R

IV. V is a neighbour of S.

Which of the following must be true?

- (a) R is the left neighbour of S. (b) Q is neighbour of R.
(c) P is not seated opposite to Q. (d) P is a neighbour of R.

Answer: c

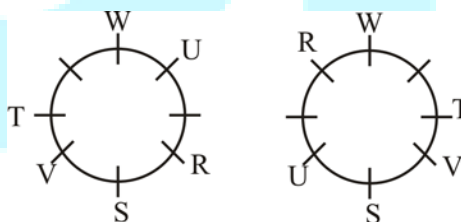

3. Repo rate is the rate at which Reserve Bank of India (RBI) lends commercial banks, and reverse repo rate is the rate at which RBI borrows money from commercial bank.

Which of the following statements can be inferred from the above passage?

- (a) Decrease in repo rate will decrease cost of borrowing and increase lending by commercial banks.
(b) Decrease in repo rate will increase cost of borrowing and decrease lending by commercial bank.
(c) Increase in repo rate will decrease cost of borrowing and increase lending by commercial bank.

(d) Increase in repo rate will decrease cost of borrowing and decrease lending by commercial bank.

Answer: a

4. The distance between Delhi and Agra is 233 km. A car P started travelling from Delhi to Agra and another car Q started from Agra to Delhi along the same road 1 hour after the car P started. The two cars crossed each other 75 minutes after the car Q started. Both cars were travelling at constant speed. The speed of car P was 10 km/hr more than the speed of car Q. How many kilometres the car Q had travelled when the cars crossed each other?

- (a) 66.6 (b) 116.5 (c) 75.5 (d) 88.2

Answer: c

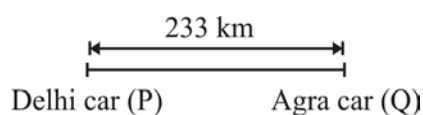

Let the speed of car Q is S km/hr speed of car P is $S + 10$ km/hr.

In starting one hour car P covered distance = $(S + 10)$ km.

In next 75 min the car Q and car P will the respectively distance, $S \times 1.25$ and $(S + 10) \times 1.25$

$$(S + 10) + S \times 1.25 + (S + 10) \times 1.25 = 233 \text{ km}$$

$$\Rightarrow 3.5S + 22.5 = 233$$

$$\Rightarrow 3.5S = 210.5$$

$$\Rightarrow S = 60.14 \text{ km / hr}$$

The distance covered by car Q = $60.14 \times 1.25 = 75.17$ km

GATE-2021 SOLUTION

CHEMICAL ENGINEERING

Subject	1-Marks	2-Marks	Total Marks
General Aptitude	5×1	5×2	15
Engg. Mathematics	4×1	4×2	12
Chemical Reaction Engineering	2×1	3×2	8
Mass Transfer	2×1	4×2	10
Process Dynamics and Control	3×1	5×2	13
Heat Transfer	4×1	3×2	10
Thermodynamics	1×1	3×2	7
Fluid Mechanics	2×1	3×2	8
Chemical Technology	1×1	1×2	3
Mechanical Operation	1×1	1×2	3
Plant Design Economic	3×1	2×2	7
Process Calculations	2×1	1×2	4
			Total = 100 Marks

CHEMICAL ENGINEERING

GATE-2022 SOLUTION



GATE-2022 Chemical Engineering

Subject	1-Marks	2-Marks	Total Marks
General Aptitude	1 × 5	2 × 5	15
Engg. Mathematics	1 × 5	2 × 5	15
Chemical Reaction Engineering	1 × 2	2 × 5	12
Mass Transfer	1 × 1	2 × 2	5
Process Dynamics and Control	1 × 5	2 × 3	11
Heat Transfer	0	5 × 2	10
Thermodynamics	1 × 2	4 × 2	10
Fluid Mechanics	1 × 1	2 × 4	9
Chemical Technology	1 × 3	1 × 2	5
Mechanical Operation	0	1 × 2	2
Plant Design Economic	1 × 2	2 × 1	4
Process Calculations	0	2 × 1	2
			Total = 100 Marks

GATE-2022 Chemical Engineering

1. A game consists of spinning an arrow around a stationary disk as shown below. When the arrow comes to rest, there are eight equally likely outcomes. It could come to rest in any one of the sectors numbered 1, 2, 3, 4, 5, 6, 7 or 8 as shown. Two such disks are used in a game where their arrows are independently spun. What is the probability that the sum of the numbers on the resulting sectors upon spinning the two disks is equal to 8 after the arrows come to rest?

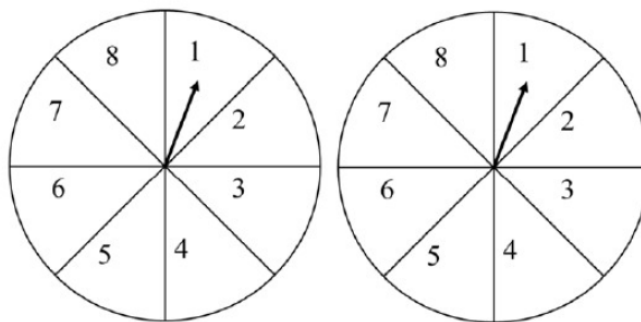

- (A) $1/16$ (B) $5/54$ (C) $3/32$ (D) $7/64$

Ans: d

Cases when numbers on resulting sectors upon spinning the two disks equal to 8
(1, 7), (2, 6), (3, 5), (4, 4), (7, 1), (6, 2), (5, 3)

Total number of cases = 7

Total number of outcome of spinning disk = $8 \times 8 = 64$

So required probability = $\frac{7}{64}$

2. Rice, a versatile and inexpensive source of carbohydrate, is a critical component of diet worldwide. Climate change, causing extreme weather, poses a threat to sustained availability of rice. Scientists are working on developing Green Super Rice (GSR), which is resilient under extreme weather conditions yet given higher yields sustainably. Which one of the following is the CORRECT logical inference based on the information given in the above passage?
- (A) GSR grows in an extreme weather, but the quantity of produce is lesser than regular rice.
 (B) GSR may be used in future in response to adverse effects of climate change.
 (C) GSR is an alternative to regular rice, but it grows only in an extreme weather.
 (D) Regular rice will continue to provide good yields even in extreme weather.

(Ans: b)

GSR gives higher yield hence option A is not correct GSR resilient under extreme weather condition hence option C is also not correct.

Regular rice not provide good yield in extreme condition.

So option D is also incorrect.

GRS is an alternative to regular rice which may be used in future in response to adverse effect on climate change.

So, option B is correct logical inference.

3. Consider the following inequalities.

$$(i) 3p - q < 4 \qquad (ii) 3q - p < 12$$

Which one of the following expressions below satisfies the above two inequalities?

(A) $p + q < 8$

(B) $p + q = 8$

(C) $p + q \geq 16$

(D) $8 \leq p + q < 16$

Ans: A

Consider the following inequalities

(i) $3p - q < 4$

(ii) $3q - p < 12$

Adding (i) and (ii)

$$(3p - q) < 4$$

$$(3q - p) < 12$$

$$\hline 2P + 2q < 16$$

$$\Rightarrow p + q < 8$$

4. Inhaling the smoke from a burning _____ could _____ you quickly.

(A) tire/tier

(B) tire / tyre

(C) tyre / tire

(D) tyre / tier

Answer: c

Example: Inhaling the smoke from a burning **Tyre** could **Tire** you quickly.

5. Pipes P and Q can fill a storage tank in full with water in 10 and 6 minutes, respectively. Pipe R draws the water out from the storage tank at a rate of 34 liter per minutes. P, Q and R operate at a constant rate.

If it takes one hour to completely empty a full storage tank with all the pipes operating simultaneously, what is the capacity of the storage tank (in litres)?

(A) 60.0

(B) 120.0

(C) 26.8

(D) 127.5

Answer: d

Example:

In 60 min pipe P will fill the tank 6 times.

So total volume filled by pipe P = 6V

in 60 minutes pipe Q will fill the tank 10 times = 10V.

In 1 hr total volume of water in the tank = 0

CHEMICAL ENGINEERING

GATE-2023 SOLUTION



GATE-2023 Chemical Engineering (General Aptitude)

Q.1 “You are delaying the completion of the task. Send _____ contributions at the earliest.”

- (A) you are (B) your (C) you're (D) yore

Answer: B

“You are delaying the completion of the task. Send *your* contributions at the earliest.

Q.2 References : _____ : : Guidelines : Implement

(By word meaning)

- (A) Sight (B) Site (C) Cite (D) Plagiarise

Answer: C

Q.3 In the given figure, PQRS is a parallelogram with PS = 7 cm, PT = 4 cm and PV = 5 cm. What is the length of RS in cm? (The diagram is representative.)

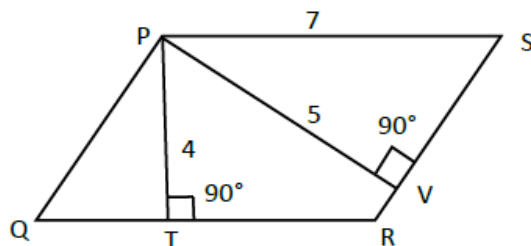

- (A) $\frac{20}{7}$ (B) $\frac{28}{5}$ (C) $\frac{9}{2}$ (D) $\frac{35}{4}$

Answer: B

Area = base \times height ; $RS \times PV = QR \times PT \Rightarrow 5 RS = 7 \times 4 = 28$

$RS = 28/5$

Q.4: In 2022, June Huh was awarded the Fields medal, which is the highest prize in Mathematics.

When he was younger, he was also a poet. He did not win any medals in the International Mathematics Olympiads. He dropped out of college.

Based only on the above information, which one of the following statements can be logically inferred with certainty?

- (A) Every Fields medalist has won a medal in an International Mathematics Olympiad.
 (B) Everyone who has dropped out of college has won the Fields medal.
 (C) All Fields medalists are part-time poets.
 (D) Some Fields medalists have dropped out of college.

Answer: D

Q.5 A line of symmetry is defined as a line that divides a figure into two parts in a way such that each part is a mirror image of the other part about that line.

The given figure consists of 16 unit squares arranged as shown. In addition to the three black squares, what is the minimum number of squares that must be coloured black, such that both PQ and MN form lines of symmetry? (The figure is representative)

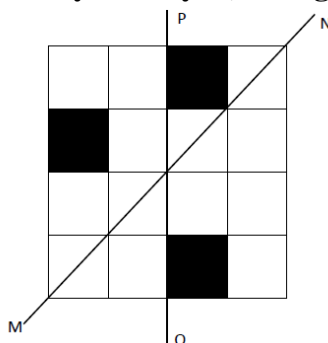

- (A) 3 (B) 4 (C) 5 (D) 6

Answer:C

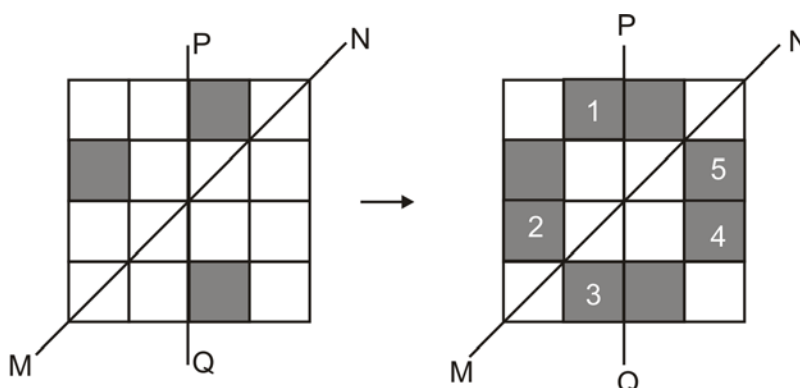

Q.6

Human beings are one among many creatures that inhabit an imagined world. In this imagined world, some creatures are cruel. If in this imagined world, it is given that the statement “Some human beings are not cruel creatures” is FALSE, then which of the following set of statement(s) can be logically inferred with certainty?

- (i) All human beings are cruel creatures.
 (ii) Some human beings are cruel creatures.
 (iii) Some creatures that are cruel are human beings.
 (iv) No human beings are cruel creatures.
- (A) only (i) (B) only (iii) and (iv)
 (C) only (i) and (ii) (D) (i), (ii) and (iii)

Q.7 To construct a wall, sand and cement are mixed in the ratio of 3:1. The cost of sand and that of cement are in the ratio of 1:2.

If the total cost of sand and cement to construct the wall is 1000 rupees, then what is the cost (in rupees) of cement used?

- (A) 400 (B) 600 (C) 800 (D) 200

Answer: A

Let cost cement be $2x$ cost of sand = x

1 part cement + 2 parts sand

$$\Rightarrow 3x + 2x$$

$$\Rightarrow 5x = 1000 \quad x = 200 \quad 2x = 400$$

Cost of cement

Let cost cement be x cost of sand = $2x$

\Rightarrow 1 part cement + 3 parts sand

$$\Rightarrow 2x + 3x \quad \Rightarrow 5x = 1000 \quad \Rightarrow x = 200 \quad \text{Cost of cement} = 2x = 400$$

Q.8 The World Bank has declared that it does not plan to offer new financing to Sri Lanka, which is battling its worst economic crisis in decades, until the country has an adequate macroeconomic policy framework in place. In a statement, the World Bank said Sri Lanka needed to adopt structural reforms that focus on economic stabilisation and tackle the root causes of its crisis. The latter has starved it of foreign exchange and led to shortages of food, fuel, and medicines. The bank is repurposing resources under existing loans to help alleviate shortages of essential items such as medicine, cooking gas, fertiliser, meals for children, and cash for vulnerable households.

Based only on the above passage, which one of the following statements can be inferred with certainty?

- (A) According to the World Bank, the root cause of Sri Lanka's economic crisis is that it does not have enough foreign exchange.
- (B) The World Bank has stated that it will advise the Sri Lankan government about how to tackle the root causes of its economic crisis.
- (C) According to the World Bank, Sri Lanka does not yet have an adequate macroeconomic policy framework.
- (D) The World Bank has stated that it will provide Sri Lanka with additional funds for essentials such as food, fuel, and medicines.

Answer: C

Q.9: The coefficient of x^4 in the polynomial $(x-1)^3(x-2)^3$ is equal to _____.

- (A) 33 (B) -3 (C) 30 (D) 21

Answer: A

$$(x-1)^3(x-2)^3$$

$$\Rightarrow (a-b)^3 = a^3 - b^3 + 3ab(a-b)$$

$$\Rightarrow [x^3 - 1 - 3x(x-1)][x^3 - 8 - 3x(x-2)]$$

$$\Rightarrow [x^3 - 1 - 3x^2 + 3x][x^3 - 8 - 3x^2 + 6x]$$

$$\Rightarrow \text{For } x^4, 6x^4 + 9x^4$$

GATE-2024

Chemical Engineering

GATE-2024

1. Three distinct sets of indistinguishable twins are to be seated at a circular table that has 8 identical chairs. Unique seating arrangements are defined by the relative positions of the people. How many unique seating arrangements are possible such that each person is sitting next to their twin?
- (A) 14
(B) 10
(C) 12
(D) 28

2. For positive integers p and q , with

$$\frac{p}{q} \neq \left(\frac{p}{q}\right)^{\frac{p}{q}} = p^{\left(\frac{p-1}{q}\right)}. \text{ Then,}$$

- (A) $q^p = p^{2p}$
(B) $q^p = p^q$
(C) $\sqrt[q]{q} = \sqrt[q]{p}$
(D) $\sqrt{q} = \sqrt{p}$
3. In the 4×4 array shown below, each cell of the first three columns has either a cross (X) or a number, as per the given rule.

1	1	2	
2	X	3	
2	X	4	
1	2	X	

Rule: The number in a cell represents the count of crosses around its immediate neighboring cells (left, right, top, bottom, diagonals).

As per this rule, the **maximum** number of crosses possible in the empty column is;

- (A) 3
(B) 2
(C) 1
(D) 0

4. Which one of the given options is a possible value of x in the following sequence?
3, 7, 15, x , 63, 127, 255
(A) 35
(B) 40
(C) 45
(D) 31
5. The chart given below compares the Installed Capacity (MW) of four power generation technologies, T1, T2, T3, and T4, and their Electricity Generation (MWh) in a time of 1000 hours (h).

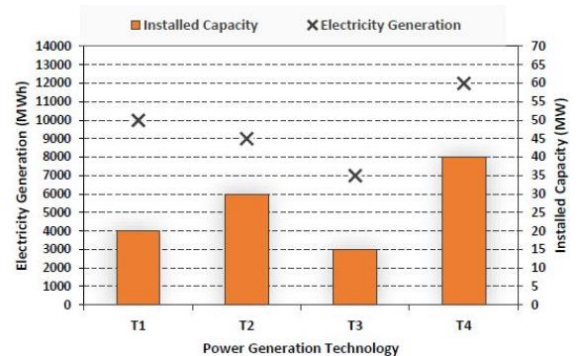

Power Generation Technology

The Capacity Factor of a power generation technology is:

$$\text{Capacity Factor} = \frac{\text{Electricity Generation (MWh)}}{\text{Installed Capacity (MW)} \times 1000(\text{h})}$$

Which one of the given technologies has the highest Capacity Factor?

- (A) T4
(B) T1
(C) T2
(D) T3

6. In a locality, the houses are numbered in the following way:

The house-numbers on one side of a road are consecutive odd integers starting from 301, while the house-numbers on the other side of the road are consecutive even numbers starting from 302. The total number of houses is the same on both sides of the road.

If the difference of the sum of the house-numbers between the two sides of the road is 27, then the number of houses on each side of the road is

- (A) 26
(B) 52
(C) 54
(D) 27

7. During a half-moon phase, the Earth-Moon-Sun form a right triangle. If the Moon-Earth-Sun angle at this half-moon phase is measured to be 89.85° , the ratio of the Earth-Sun and Earth-Moon distances is closest to

- (A) 283
(B) 328
(C) 238
(D) 382

8. On a given day, how many times will the second-hand and the minute-hand of a clock cross each other during the clock time 12:05:00 hours to 12:55:00 hours?

- (A) 49
(B) 55
(C) 50
(D) 51

9. In the given text, the blanks are numbered (1)–(iv). Select the best match for all the blanks.

From the ancient Athenian arena to the modern Olympic stadiums, athletics __ (i) __ the potential for a spectacle. The crowd __ (ii) __ with bated breath as the Olympian artist twists his body, stretching the javelin behind him. Twelve strides in, he begins to cross-step. Six cross-steps __ (iii) __ in an abrupt stop on his left foot. As his body __ (iv) __ like a door turning on a hinge, the javelin is launched skyward at a precise angle.

(A)	holds	wait	culminates	pivot
(C)	hold	waits	culminates	pivot
(C)	holds	waits	culminate	pivots
(D)	hold	wait	culminate	pivots

10. If '→' denotes increasing order of intensity, then the meaning of the words [simmer→seethe→smolder] is analogous to [break→raze→_____].

Which one of the given options is appropriate to fill the blank?

- (A) obliterate
(B) obfuscate
(C) fracture
(D) fissure

11. The first non-zero term in the Taylor series expansion of $(1-x) - e^{-x}$ about $x=0$ is:

- (A) $-\frac{x^2}{2}$ (B) 1
(C) -1 (D) $\frac{x^2}{2}$

12. An infinitely long cylindrical water filament of radius R is surrounded by air. Assume water and air to be static. The pressure outside the filament is P_{out} and the pressure inside is P_{in} . If γ is the surface tension of the water-air interface, then $P_{in} - P_{out}$ is













- (A) $\frac{2\gamma}{R}$ (B) $\frac{\gamma}{R}$
(C) $\frac{4\gamma}{R}$ (D) 0

13. If $z_1 = -1 + i$ and $z_2 = 2i$, where $i = \sqrt{-1}$, then $\text{Arg}(z_1/z_2)$ is

- (A) $\frac{\pi}{2}$ (B) $\frac{\pi}{4}$
(C) $\frac{3\pi}{4}$ (D) $\frac{\pi}{3}$

14. The opposite faces of a metal slab of thickness 5 cm and thermal conductivity $400 \text{ W m}^{-1} \text{ }^\circ\text{C}^{-1}$ are maintained at 500°C and 200°C . The area of each face is 0.02 m^2 . Assume that the heat transfer is steady and occurs only in the direction perpendicular to the faces. The magnitude of the heat transfer rate, in kW, rounded off to the nearest integer, is _____

6 Rank in Top 10

 3 Rank KRISH PARADVA	 4 Rank SMIT MAGANLAL VAGADIYA	 5 Rank TUTHIKA MAHESH ANIL
 6 Rank PARAM AGRAHARI	 6 Rank DEBARGHYA CHAKRABARTI	 9 Rank KEVAL VASOYA
 11 Rank PRAVEEN KUMAR YADAV	 15 Rank BRANZIL	 16 Rank NISTHA ROY
 39 Rank MANSUR MUSTAFA	 42 Rank NITIN SINGH	 52 Rank NISHANT PATHAK

and many more

CLASSROOM COACHING

-  REGULAR & WEEKEND BATCH
-  CRASH COURSE 80-90DAYS
-  SUMMER BATCH 75DAYS

ONLINE-LIVE COACHING

-  PEN-DRIVE LECTURES
-  ONLINE-TEST SERIES
-  POSTAL-STUDY MATERIALS

 **ENGINEERS**
INSTITUTE OF INDIA

India's Best Institute for CHEMICAL ENGINEERING



ISBN: 9789351377542

Price Rs. 849/-

Head office: 61C, Kalu Sarai Near Hauz Khas Metro Station New Delhi-16

Helpline: 9990657855

 9990357855

www.engineersinstitute.com

www.gatechemical.com